

MOZA AIR2

User Manual
用户手册

Contents

■ MOZA Air 2 Overview	1
■ Air 2 Installation	2
• Attaching the Tripod	2
• Installing Batteries	2
• Mounting the Camera	3
• Connecting Camera Control Cable	4
• Installing the Support Rod	4
• Mounting the Riser Plate	5
■ Balance Adjustment	6
• Lock the Roll Axis	6
• Balancing the Camera	6
• Balancing the Tilt Axis	6
• Balancing the Roll Axis	7
• Balancing the Pan Axis	7
■ Gimbal Operation	8
• Buttons and OLED Display	8
• Power on/off, Sleep, Wake up	8
• Camera Setting and Control	9
• Smart Wheel Working Modes	10
• Re-center, take selfie and etc	10
• Inception Mode and auto tuning	12
■ Menu Description	12
■ Tips	15
• Operation Modes	15
• Gyroscope Calibration	16
• Accelerometer Calibration	16
• Balance Test	17
• Offset	17
• Firmware Upgrade	18
■ SPECS	19

目录

■ 认识Air 2	20
■ 安装Air 2	21
• 三脚架的安装和使用	21
• 电池的安装拆卸	21
• 相机的安装和拆卸	22
• 相机控制线的安装	23
• 跟焦安装管的安装和拆卸	23
• 增高组件的使用	24
■ 平衡调节	25
• 锁定横滚轴	25
• 快装板前后调节	25
• 俯仰臂调节	25
• 横滚臂调节	26
• 航向臂调节	26
■ 云台功能	27
• 按键功能及主界面介绍	27
• 开/关机、休眠/唤醒	27
• 相机控制	28
• 跟焦，横滚控制	29
• 归中、自拍、全锁定	30
• 切换跟随状态	30
• 极速跟随、盗梦空间及自动调参	31
■ 菜单	31
■ 使用技巧	34
• 操作模式	34
• 陀螺仪校准	35
• 加速度计校准	35
• 平衡检查	36
• 平衡微调	36
• 固件升级	37
■ 规格参数	38

MOZA AIR 2 Overview

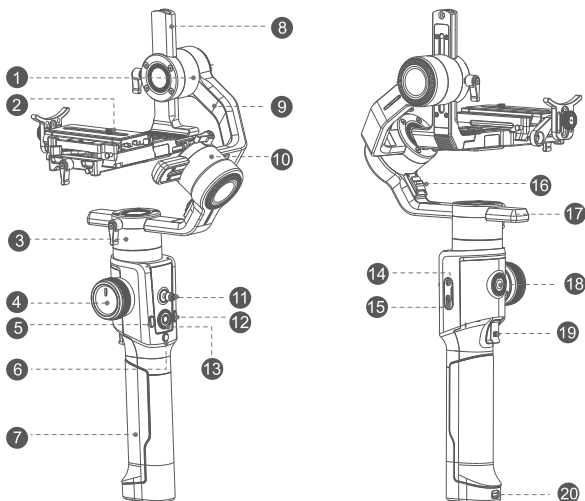

- | | | | |
|--|-----------------|-------------------------------|-----------------------|
| 1 Tilt Motor | 6 Power Button | 11 Joystick | 16 Roll Motor Lock |
| 2 Mechanical Memory Quick Release System | 7 Battery Hatch | 12 Fn Button | 17 Pan Arm |
| 3 Pan Motor | 8 Tilt Arm | 13 Dial | 18 3/8 Extension Port |
| 4 Wheel | 9 Roll Arm | 14 DC Input Port | 19 Smart Trigger |
| 5 M Button | 10 Roll Motor | 15 Tune/Firmware Upgrade Port | 20 Battery Hatch Lock |

AIR 2 Installation

Attaching the Tripod

2 screw holes are equipped at the bottom of grip: 1/4" for mini tripod and 3/8" for large accessories like slider and big tripod. Screw the mini tripod, then expand as shown below.

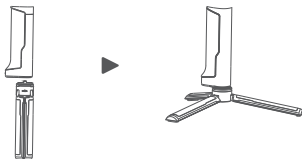

Installing Batteries

⚠ Note: Please pay attention to the battery poles for fear of short circuit.

a. Hold the battery hatch slightly, push the lock downward, slide the hatch as shown below and then release the lock.

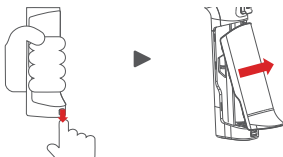

b. Insert the batteries one by one as shown.

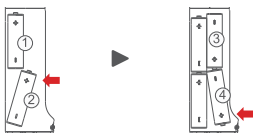

c. Cover the battery hatch.

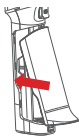

Mounting the Camera

The Air 2 quick release plate is equipped with 2 screws, select an appropriate one according to the camera type. There is no limit to the installing direction of the quick release plate. When mounting the camera, make sure the lens slightly extends beyond the quick release plate in order to reserve extra room for lens support and rod adaptor

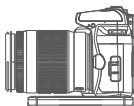

- After mounting the camera onto the quick release plate, loosen the lever A, then slide the quick release plate onto the baseplate. The quick release plate can be installed from both back and forth.
- Please make sure the safety lock 1 and 2 will eject once each, and a rough back and forth balance is reached.

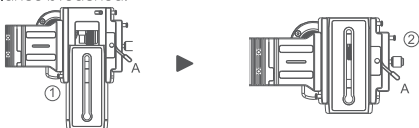

- Press the safety lock 1, the quick release plate will be removed in the direction shown below.

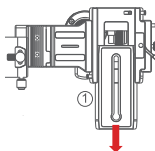

- Press the safety lock 1, slide the plate as shown below, then press the lock 2 when the plate is moved to the end. The quick release plate will be removed in the reverse direction.

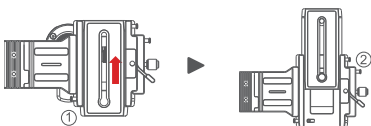

⚠ Note: It is recommended to use the lens support for the best effect.

Connecting Camera Control Cable

4 different control cables are stored in the tool box

- M3C-Mini cable: For cameras with Mini port like Canon 5D3, etc
- M3C-Micro cable: For cameras with Micro port like Canon 5D4, etc
- MCSC-Remote cable: For Panasonic cameras with 3.5mm port like GH3, GH4, etc
- MCSC-Multi cable: For Sony cameras with Multi port like A7s II , A7 III , etc

Connect the control cable to the CAM CTRL port on the Air 2 gimbal, and then the other end to the control port on the camera. The camera icon will be displayed on the OLED screen. Then parameters adjusting, video recording or photo taking, and follow focus can be directly operated on the gimbal.

! Note:

- For details of different cameras and lenses, please refer to the page 9.
- If USB control is not supported, please choose your camera type manually.



Installing the Support Rod

Please install the rod before using the follow focus.

Take out the rod adaptor, M3x10 screws, Allen wrench first. Fix the adaptor on the front or back of the quick release plate with M3x10 screws, then revolve the support rod into the adaptor.

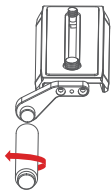

When installed at the left side, please match the stud of the rod adaptor and the screw hole of the support rod, then tighten the support rod counterclockwise.

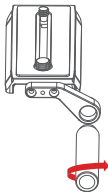

When installed at the right side, please match the screw hole of the rod adaptor and the stud of the support rod, then tighten the support rod clockwise.

! Note: Please install the support rod and rod adaptor according to the position shown above for fear of falling off.

Mounting the Riser Plates

The riser plates need to be used in the follow cases:

- a. The camera is too short to balance the tilt axis
- b. The lens is too short to install the follow focus
- c. The follow focus needs to be installed for zoom

⚠ Note: If the rod adaptor has been installed before mounting the riser plates, please remove the adaptor first.

Fix the riser plates in the screw holes on both ends of the quick release plate, then fix the other quick release plate onto the riser plates in the same way.

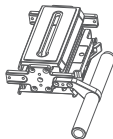
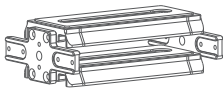

There are also screw holes on the riser plates for installing the rod adaptor.

Balance Adjustment

⚠ Note: In order to make the adjustment easier, please refer to the balance check function of Air 2 on page 18.

Lock the Roll Axis

Move the roll motor lock to the lock end, rotate the roll arm to the position shown below, then the roll arm will automatically lock.

⚠ Note: If the roll arm locks in the position overlapping the pan arm, please unlock the roll motor first)

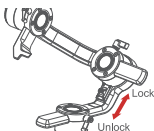

Balancing the Camera

- Mount the camera onto the Air 2, release hands to check if the camera is top or bottom heavy.
- If the camera is bottom heavy, loosen the knob to slide the quick release baseplate forwards until the lens points forward.
- If the camera is top heavy, loosen the knob to slide the quick release baseplate backwards until the lens points forward.
- Tighten the knob.

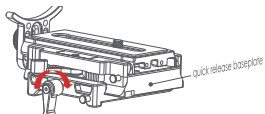

Balancing the Tilt Axis

- Rotate the camera so that the lens is pointing upward, release hands to check the direction in which the camera swings.
- Loosen the knob 1 on the tilt motor to slide the tilt arm 2 until the camera stays still without tilting it up or down.
- Tighten the knob 1.

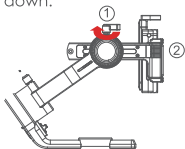

Balancing the Roll Axis

- Move the roll motor lock switch to the unlock end.
- Release hands to observe the direction in which the roll axis swings.
- Loosen the roll axis knob 1 to slide the roll arm 2 until the roll arm 2 stays still.
- Tighten the knob 1.

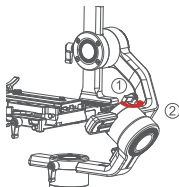

Balancing the Pan Axis

- Grab the Air 2 horizontally, make the pan arm level. Release hands to check the direction in which the camera swings.
- Loosen the knob 1 on the pan motor. Move the pan arm 2 leftwards or rightwards until it keeps level.
- Tighten the knob 1.

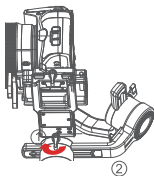

⚠ Note: If the balance of the pan axis is not adjusted properly, the pan axis may become hot, and the inception mode cannot be used properly.

Buttons and OLED Display

Button Functions:

State	Press	Power button	Fn button	Smart Trigger	M button	Wheel	Joystick Button
Main interface	1x	Start/stop recording	Sport gear mode	—	Switch wheel modes	Control the function chosen by	Enter/exit pan follow
	2x	Photo	Inception mode	Re-center	—		Enter/exit roll follow
	3x	—	—	Selfie	—		Enter/exit tilt follow
	3s	On/off	Auto tune	—	—	—	
	hold	—	—	All lock	—	M button	—

State	Press	Dial top button	Down button	Left button	Right button	Menu button	Dial
Main interface	1x	Enter/exit TV adjustment	Enter/exit AV adjustment	Enter/exit ISO adjustment	Enter/exit preview	Enter the menu	follow speed
	Press 3s	—	—	—	—	Sleep/wake up	—
Camera set	1x	Enter/exit TV adjustment	Enter/exit AV adjustment	Enter/exit ISO adjustment	Enter/exit preview	Enter the menu	Set camera parameters
Main interface	1x	Option-up	Option-down	Return to previous	Next/enter/select	Exit the menu	Switch/adjust
Power-off	Upgrade mode	Center button + power button					

OLED Icons Introduction:

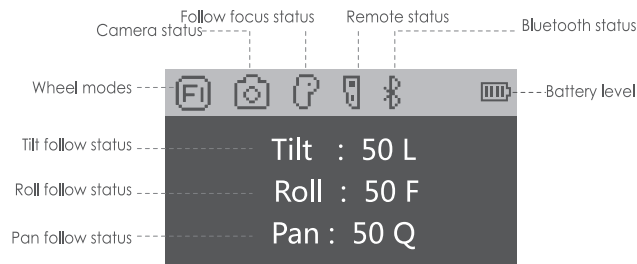

Follow status note:

Number: follow speed L: lock F: Follow Q: Sport gear mode

! Note: Device icons will not be displayed if they are not connected to the gimbal.

Power on/off. Sleep. Wake up

Long press the power button for 3 seconds until the main interface status is displayed on the screen to power on, long press for 3 seconds again to power off.

⚠ Note: Don't release the power button until the main interface is displayed on the screen, otherwise the Air 2 will not work properly.

In the power-on state, long press the menu button for 3s to enter the sleep mode. The motors stops working, but the OLED screen continues to display the status. Press the button again for 3s to wake up the Air 2.

Camera Setting and Control

⚠ Note: Please refer to the page 4 to connect the gimbal and camera first with camera control cables. MOZA Air 2 supports the parameter adjustment and auto-identification of cameras with USB control. For those cameras do not support USB control, such as Panasonic GH3/GH4/GH5, please select the camera type manually.

Air 2 camera compatibility list:

Camera			Air 2			Functions						
Brand	Model	Operation	Operation	Cable	supply	Shutter	Record	AV	TV	ISO	EV	LV
Canon	1DX	—	Select 'Canon-USB' control mode Menu>Cameraset>Select>Canon-USB	M3C-Mini	—	OK	OK	OK	OK	OK	OK	OK
	5D2					OK	OK	OK	OK	OK	OK	
	5D3					OK	OK	OK	OK	OK	OK	
	6D					OK	OK	OK	OK	OK	OK	
	6D2			OK		OK	OK	OK	OK	OK		
	80D			OK		OK	OK	OK	OK	OK		
	5D4			OK		OK	OK	OK	OK	OK		
	5Ds			OK		OK	OK	OK	OK	OK		
Sony	RX10 II	Set the USB mode to PC-Control	Select 'Sony-USB' control mode Menu>Cameraset>Select>Sony-USB	M3C-Micro	OK	—	—	—	—	—	—	—
	RX10 III					OK	—	OK	OK	OK		
	RX100M4					OK	—	OK	OK	OK		
	A5100					OK	OK	OK	OK	OK		
	A6300					OK	OK	OK	OK	OK		
	A6500					OK	OK	OK	OK	OK		
	A7S					OK	OK	OK	OK	OK		
	A7S II					OK	OK	OK	OK	OK		
	A7R					OK	OK	OK	OK	OK		
	A7R II					OK	OK	OK	OK	OK		
	A7 II					OK	OK	OK	OK	OK		
Idem	—	—	MCSC-Multi	—	OK	OK	—	—	—	—		
Panasonic	GH3	—	Select 'Panas-2.5mm' control mode Menu>Camera set>Select>Panas-2.5mm	MCSC-Remote	—	OK	OK	—	—	—	—	—
	GH4					OK	OK	—	—	—		
	GH5					OK	OK	—	—	—		
	GH5S					OK	OK	—	—	—		
	G7					OK	OK	—	—	—		
	G85					OK	OK	—	—	—		
	G9					OK	OK	—	—	—		

⚠ Note: The camera types and functions supported by the Air 2 will be continuously updated. Please visit www.gudsen.com or contact the tech support for the latest list.

- Start/Stop: Press power button once
- Shoot photos: Press power button twice
- Adjust shutter: Press the up button of the dial (TV)
- Adjust aperture: Press the down button of the dial (AV)
- Adjust ISO: Press the left button of the dial (ISO)



When adjusting camera parameters, press the corresponding button and the screen will display the value, then turn the dial to adjust the value. After the adjustment is completed, press the corresponding button again to turn off the adjustment of camera parameters.

- Turn on/ off preview: press the right button of the dial to turn on or off live preview.

⚠ Note: Only when start camera settings can turn the dial adjust parameters. Under the default state, turn the dial would adjust the follow speed. Please refer to page 11 to get more follow modes information. Some cameras with sensor, like Sony A7S2 will shut down the screen and switch to viewfinder for preview, if there is obstruction before the viewfinder. Set preview setting to screen

Smart Wheel Working Modes

The smart wheel of Air 2 has 4 working modes. press the M button to switch the modes. The icon of the smart wheel mode changes correspondingly as below:

- F1** Focus channel 1, control follow focus
- F2** Focus channel 2, control follow focus
- FE** Electronic Focus channel. If your camera and lenses support electronic follow focus, you can use the channel to control electronic focus function.
- R** Roll axis control. Control the roll axis of Air 2

⚠ Note

1. If connecting only one follow focus, both F1 and F2 channels can control the follow focus. When connecting two follow focus, then the two channels control the follow focus respectively.
2. To use the electronic focus function, please refer to www.gudsen.com, the camera function support list.

Use the smart trigger to re-center, take selfie and etc.

The Air 2 smart trigger has the following three operations to quickly control the movement of the Air 2.

- Double press: Re-center. Make the gimbal quickly return to the starting position
- Triple press: Selfie. Air 2 turns the lens towards the user
- Hold: Enter the all lock mode. Release the button, the gimbal returns to the default follow mode.

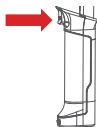

⚠ Note: When re-center and selfie, please do not rotate the handgrip, otherwise the final position will be deviated.

Switch Follow Modes

Each axis of Air 2 has follow function, and the follow functions of each axis can be independently controlled.

No.	Tilt	Roll	Pan	Note
1	Lock	Lock	Lock	All lock
2	Lock	Lock	Follow	Pan follow
3	Lock	Follow	Lock	Roll follow (FPV)
4	Lock	Follow	Follow	Pan-Roll follow
5	Follow	Lock	Lock	Tilt follow
6	Follow	Lock	Follow	Pan-Tilt follow
7	Follow	Follow	Lock	Roll-Tilt follow
8	Follow	Follow	Follow	All follow

- Turning on/off the pan motor follow: press the joystick button
- Turning on/off the roll motor follow: Double-press the joystick button
- Turning on/off the follow of the Tilt motor: Triple-press the joystick button

Adjust the follow speed of each axis: Under the default status, turn the dial and the follow speed values of the axes on the screen will change.

Quickly enter full lock: When press and hold the smart trigger, the follow mode of each axis will become 'L' (locked mode). When release the smart trigger, the gimbal returns to original mode.

Sport gear mode: Press the Fn key, the pan motor enters the sport gear mode. The letter after 'Pan' changes to 'Q', and other axes remain unchanged. Press the Fn key again to exit the mode, and the pan motor returns to the original follow mode.

Use the Fn button to enter the Inception Mode and auto tuning

The Fn button is a special function button that allows you to quickly access various special functions.

- Press: Turn on/off the sport gear mode. Under the mode, the pan motor steers quickly.
- Double-press: Enter/exit the Inception Mode. When using the Inception Mode, point the handle to the subject, then turn the joystick to the left or right to shoot a 360° rotation. The speed of the Inception Mode can be adjusted, please refer to page 15
- Long press: To automatically tune the parameters. Under this condition, the Air 2 should be installed on a tripod, and place it on a horizontal and stable desk. Air 2 will check the axis load one by one and automatically tune the power of the motor to make it in optimal state.

Menu Description

Marks description and operation

- If there is a '>' mark on the right side of the selected item, press the dial right button for the next menu.
- If the selected item has a '[' and contains a number, rotate the dial to adjust the value.
- If the selected item has a ')' and contains an option, press the right button to switch among options.



Note:

- 1 If there is a '*' on the right side of one item, the current list is the final option. Press up/down button to select an item, then press right button to move the '*' to the selected item and launch it.
2. If the selected item and other items in the menu list don't have any marks, press the dial right button to start the option once. '?' is displayed during the process, 'OK' is displayed after the process is completed, and 'ERR' is displayed if the option fails.

L1	L2	L3	L4	L5	Note		
Camera Set>	Select>	Shutter cable	—		Shutter Control		
		Canon-USB	—		Canon USB Control		
		Sony-Multi	—		Sony Multi Control		
		Sony-USB	—		Sony USB Control		
		Panas-2.5mm	—		Panasonic Remote Control		
		Panas-USB	—		Panasonic USB Control		
		Nikon-USB	—		Nikon USB Control		
		Fuji-USB	—		Fuji USB Control		
	BMD-LANC	—		BMD Remote Control			
	Parameter>	Aperture[]	—		Adjust Aperture		
		Shutter[]	—		Adjust Shutter		
ISO[]		—		Adjust ISO			
EV[]		—		Adjust Exposure Compensation			
Gimbal Set>	Motor>	Switch()	—		Turn on/off The Motor		
		Power>	Autotune	—		Start Auto Tune	
			Level>	Ultra light			Set the motor parameters to ultra light
				Light			Set the motor parameters to light
				Medium			Set the motor parameters to medium
				Heavy			Set the motor parameters to heavy
				Ultra heavy			Set the motor parameters to ultra heavy
			Custom>	Tilt[]			Set the power of the tilt motor
				Roll[]			Set the power of the roll motor
				Pan[]			Set the power of the pan motor
			Filter	Tilt[]			Set the filtering parameters of the tilt motor
		Roll[]				Set the filtering parameters of the roll motor	
		Pan[]				Set the filtering parameters of the pan motor	
		Follow>	Switch>	Tilt()			Turn on/off the follow of tilt motor
				Roll()			Turn on/off the follow of roll motor
				Pan()			Turn on/off the follow of pan motor
			Speed>	Tilt[]			Sets the follow speed of the tilt motor
				Roll[]			Sets the follow speed of the roll motor
				Pan[]			Sets the follow speed of the pan motor
			Dead angle>	Tilt[]			Set the dead angle of the tilt motor
				Roll[]			Set the dead angle of the roll motor
				Pan[]			Set the dead angle of the pan motor
		Manual pos>	Tilt()	—		Turn on the manual positioning of the tilt motor	
Roll()	—			Turn on the manual positioning of the roll motor			
Pan()	—			Turn on the manual positioning of the pan motor			

L1	L2	L3	L4	L5	Note
Gimbal Set>	Operations>	Joystick> (Set functions of the joystick)	Function>	Left-Right ()	Set the left and right functions
				Up-Down ()	Set the up and down functions
			Sensitivity>	Left-Right ()	Set the left and right sensitivity
				Up-Down ()	Set the up and down sensitivity
			Habits> (Set the directions)	Left-Right ()	+: forward ; - reverse
				Up-Down ()	+: forward ; - reverse
		Wheel> (Set functions of the smartwheel)	Function>	Focus-1	Control the follow focus 1
				Focus-2	Control the follow focus 2
				Focus-E	Control the electronic follow focus
				Roll	Control the roll axis
			Sensi()	—	Set the sensitivity of the smartwheel
		Habits()	—	+: forward ; -: reverse	
		Trigger>	Hold> (Press and hold the smart trigger)	None	non-functional button
				All lock	Enter all lock mode
				Quick follow	Enter sport gear mode
				FPV	Enter FPV mode
				+ P&Y follow	Turn on tilt and pan follow
				+ P follow	Turn on tilt follow
				+ R follow	Turn on roll follow
				+ Y follow	Turn on pan follow
			Once> (Single Press the Smart Trigger)	None	non-functional button
	Re-center			Re-cent	
	selfie			Take the selfie	
	Shutter			Take photos	
	Twice> (Double Press the Smart Trigger)			None	non-functional button
	Re-center			Re-cent	
	selfie			Take the selfie	
	Triple >	None	non-functional button		
		Re-center	Re-cent		
		selfie	Take the selfie		
	Dial	Habits()	—	Set the directions [+: forward ; -: reverse]	
	Calibration>	Offset>	Tilt()	—	Offset of Tilt Axis
			Roll()	—	Offset of Roll Axis
Pan()			—	Offset of Pan Axis	
Balance chk>		back --- front	—	Balance test results of front and back positions of camera	
		down --- up	—	Balance test results of tilt axis	
		left --- right	—	Balance test results of roll axis	
Gyro		—	Gyroscope calibration		
Acc		—	Accelerometer calibration		

L1	L2	L3	L4	L5	Note
Advanced>	iFocus Set>	Turn off	—		Turn off Follow Focus
		Turn on	—		Turn on Follow Focus
		Set point A	—		Set start point of follow focus
		Set point B	—		Set end point of follow focus
	Inception>	Speed[]	—		Set the rotation speed of Inception Mode
		Smooth[]	—		SetSmoothness of Inception Mode
AHRS coeff[]	—	—		set attitude parameters	
Tripod mode()	—	—		Turn on/off Tripod Mode	
Configuration>	Config 1>	Save	—		Save to Configuration 1
		Load	—		Load Configuration 1
	Config 2>	Save	—		Save to Configuration 2
		Load	—		Load Configuration 2
	Config 3>	Save	—		Save to Configuration 3
		Load	—		Load Configuration 3
Set default	—	—		Restore Default Configuration	
About>	—	—	—		Firmware Version

Tips

Operation Modes

There are three operation modes for the MOZA Air 2



Vertical mode

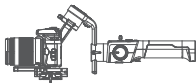

Flashlight mode



Underslung mode

⚠ Note: Rotate the handgrip around the roll motor to 180 degrees above the camera.

Calibration and Firmware Upgrade

Gyroscope Calibration

- Make sure the motors are turned off before calibration. Long press the menu button, or enter the menu and select motor > turn off to turn off the gimbal.
- Place the Air 2 on a stable desktop and keep it stationary.
- Enter the menu, select calibrate > Gyro cali, and press the right dial to calibrate the gimbal.
- Wait about 5 seconds, when the '?' changes to 'OK', the calibration is completed.

Offset	>	Offset	>
Balance chk	>	Balance chk	>
Gyro	?	Gyro	OK
Acc		Acc	

⚠ Note: Gyroscope calibration is only required if the gimbal drifts (if the gimbal moves by itself without input from the joystick) 2. If the 'ERR' prompt appears after calibration, the calibration fails, please try again.

Accelerometer Calibration

- Make sure the motors are turned off before calibration. Long press the menu button, or enter the menu and select motor > turn off to turn off the gimbal.
- Place the gimbal horizontally and keep it stationary

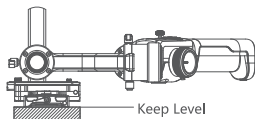

- Enter the menu, select calibrate > Acc cali, and press the right dial to enter calibration.
- Wait about 5 seconds, when the '?' changes to 'OK', the calibration is completed.

Offset	>	Offset	>
Balance chk	>	Balance chk	>
Gyro		Gyro	
Acc	?	Acc	OK

⚠ Note: Accelerometer calibration is only required if the camera is not kept level. In case of emergency shooting, the camera can be adjusted to a horizontal state by balance fine-tuning. Please refer to page 18 for details. If the 'ERR' prompt appears after calibration, the calibration fails, please try again.

Balance Check

The Air 2 can check the balance status of each axis by itself and guide the user to adjust correctly.

- Attach a tripod to Air 2 and place it on a horizontal tabletop.
- Enter the menu, select **calibrate > Balance chk**, and the Air 2 begins to check the balance adjustment.

⚠ Note: The gimbal cannot be checked for balance when motors are powered off, and 'ERR' will be prompted on the screen. Please long press the menu button, turn on the gimbal and try again.



back--*--front: If the * is close to back, the camera's position is backward and needs to be adjusted forward; If the * is close to front, the camera's position is forward and needs to be adjusted backward. Please refer to page 6.

down--*--up: If the * is close to down, the tilt arm's position is too low and needs to be adjusted upwards. If the * is close to up, the tilt arm's position is too high and needs to be adjusted downward. Please refer to page 7.

left--*--right: If the * is close to the left, the roll arm's position is too left and needs to be adjusted to the right. If the * is close to right, the roll arm's position is too right and needs to be adjusted to the left. Please refer to page 7.

⚠ Note:

- After the test results are displayed on the screen, long press the menu button to turn off the gimbal, and then adjust each axis, then press the menu button return to wake up the gimbal
- The balance of the pan axis can't be checked right now. Please adjust it according to the operation instruction on page 7.

Offset

In case of emergency shooting, the camera can be adjusted to a horizontal state by offset.

- Turn on the gimbal and the camera level, check the offset of the tilt and pan axis.
- Enter the menu, select **calibrate > offset**, select an axis that is not horizontal, and then turn the dial to adjust the fine adjustment value of the axis until the camera is completely level.

Offset	>		Tilt	[50]
Balance chk	>	▶	Roll	[50]
Gyro			Pan	[50]
Acc				

⚠ Note:

- The offset can only adjust the angle of each axis within the range of about $\pm 5^\circ$. If there is too much offset, the camera cannot be completely leveled.
- offset is only a temporary solution. After shooting, accelerometer calibration is still needed.
- The parameters of offset will not be saved and will become invalid after restart.

Firmware Upgrade

Upgrade via computer:

- Turn off the gimbal.
- Long press the joystick, then press the power button with your another hand until the prompt "Boot Mode" appears on the screen.
- Connect the gimbal to the computer with a USB Type-C cable.
- The software will automatically identify the device and load the firmware. Press the "Upgrade" button and wait for about 10s.
- During the upgrade process, 'upgrading' will be displayed on the gimbal screen, and 'upgrade success' will be displayed on the screen after the upgrade is completed. After the upgrade completes, unplug the USB cable and restart Air2.

Upgrade Via App:

- Turn off the gimbal.;
- Long press the joystick, then press the power button with your another hand until the prompt "Boot Mode" appears on the screen.
- Start App, press Bluetooth to search for Air 2 device and connect.
- The App will automatically enter the firmware upgrade interface, please wait for the firmware download to complete, press the 'upgrade' button and wait for about 5 minutes.
- During the upgrade process, 'upgrading' will be displayed on the gimbal screen, and 'upgrade success' will be displayed on the screen after the upgrade is completed, and then air 2 can be restarted.

Specifications

Air 2	
Payload Range	0.3kg~4.2kg
Dimension	230*240*470 mm
Tilt Camera Tray Dimension	110 mm
Roll Camera Tray Dimension	100 mm
Pan Mechanical Endpoint Range	360°
Roll Mechanical Endpoint Range	360°
Tilt Mechanical Endpoint Range	+180°~-95°
Battery Type	INR18650D250
Battery Capacity	2500 mAh
Working Voltage	15.2V
Static Current	150mA
Communication	BLUETOOTH 4.0 BLE
	2.4G
	USB
Camera Control Port	Mini USB 5V 1A
Dummy Battery Port	DC2.0mm 7.8V 1A
Accessory Power Supply Port	DC5.5mm 12V 2A
External Power Supply Port	DC5.5mm 14.8V 3A
Temperature	0-50 C

认识Air 2

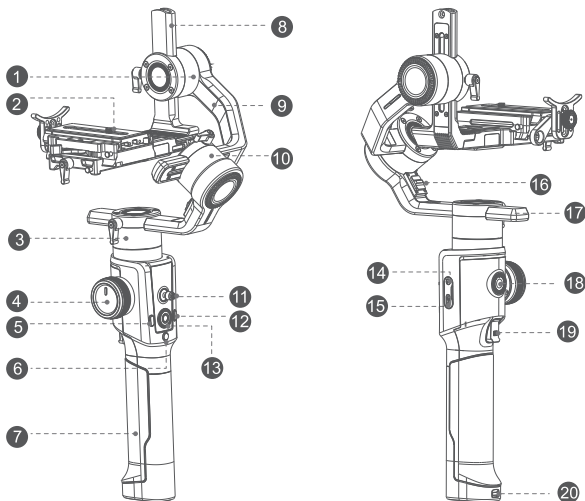

- | | | | |
|------------|---------|--------------|-------------|
| 1 俯仰电机 | 6 电源按钮 | 11 摇杆 | 16 横滚电机锁 |
| 2 机械记忆快装系统 | 7 电池仓盖 | 12 Fn键 | 17 航向臂 |
| 3 航向电机 | 8 俯仰臂 | 13 拨盘 | 18 3/8"扩展接口 |
| 4 手轮 | 9 横滚臂 | 14 DC输入接口 | 19 扳机键 |
| 5 M键 | 10 横滚电机 | 15 调参及固件升级接口 | 20 电池仓盖开关 |

安装Air 2

三脚架的安装和使用

Air 2底部带有一个1/4" 螺丝孔和一个3/8" 螺丝孔，使用桌面三脚架时，将三脚架拧入1/4" 的螺丝孔中，再展开三脚架，即可将Air 2放置在桌面等平整的地方。

如果需要将Air 2安装到大型三脚架、滑轨等设备上，则可以直接安装在3/8" 的螺丝孔上，拧紧即可。

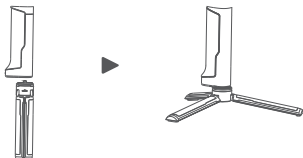

电池的安装和拆卸

⚠ 安装电池时，请注意电池的方向，如果电池装反，会导致电池短路

- a. 轻微握紧电池仓盖，将电池仓盖开关向下拨，然后将电池仓盖向外滑出，松开电池仓盖开关即可

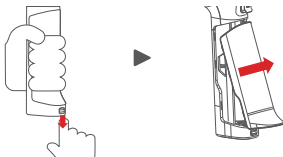

- b. 将电池按下图的方向和顺序，逐一装进电池仓中



- c. 将电池仓盖上方的卡扣插入电池仓上的相应缺口中，再将电池仓盖向内按压，直到电池仓盖开关锁止即可



相机的安装和拆卸

Air 2所配的快装板，带有一个1/4" 螺丝，一个3/8" 螺丝，根据相机底部的固定螺丝孔，选择合适的螺丝即可。将多余的螺丝拆下，装入附件收纳包中，防止丢失。

Air 2所配的快装板没有前后方向性要求，无论朝前或朝后滑入都可以正常安装。将相机固定到快装板上时，让镜头略微超出快装板，以便安装镜头支架及跟焦安装管转接支架。

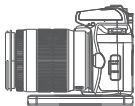

- 固定好相机后，松开锁紧扳手A，将快装板插进快装底座中，快装板没有方向要求，从前方或后方都可以正常安装
- Air 2的快装系统具有记忆功能，在插入快装板时，请确认安全销1和安全销2均已有效锁止快装板，快装板无法前后移动。然后通过锁紧扳手A锁紧快装板

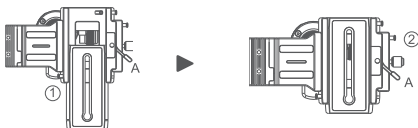

- 拆卸快装板时，如果按住安全销1，则可以将快装板从前面直接抽出

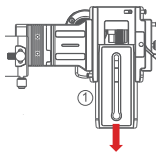

- 如果需要向后取出快装板，则需要先按住安全销1，然后向后滑动快装板，在快装板移动到尽头时，需要按住安全销2，才能将快装板完全取下

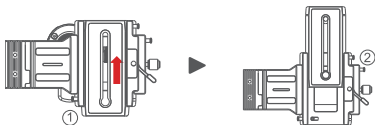

⚠ 注意：为达到最佳使用效果，建议您使用镜头支架

相机控制线的安装

Air 2配有4条相机控制线，全部收纳于附件收纳包中

- MOZA相机控制线-Mini：适用于配备Mini USB接口的相机，如佳能5D3等
- MOZA相机控制线-Micro：适用于使用配备Micro USB接口的相机，如佳能5D4等
- MOZA相机快门线-Remote：适用于配备3.5mm接口的松下相机，如GH3、GH4等
- MOZA相机快门线-Multi：适用于配备Multi接口的相机，如索尼A7sII、A7III等

连接相机控制线时，先将弯头Mini USB端插入AIR 2的相机控制接口Cam Ctrl，再将另一端插入相机的USB口或控制口即可。相机连接成功后，Air 2屏幕上会显示相机图标，您可以使用Air 2来控制相机

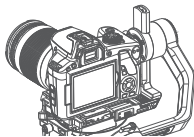

⚠ 注意：

- 不同相机及镜头支持的功能会有差异,详细情况请参考第28页的相机控制部分
- 不支持USB协议的相机在连接到Air 2云台后不会自动显示相机图标，需要手动选择对应的相机型号才能完成相机控制线的安装，详细操作请参考第28页

跟焦安装管的安装和拆卸

当需要在Air 2上安装跟焦器时，需要先安装好跟焦安装管。

从附件收纳包中取出跟焦安装管转接支架*1、M3*10螺丝*2、H2内六角扳手*1，将转接支架固定在快装板前面的螺纹孔中，然后将跟焦安装管安装在跟焦安装管转接支架即可。

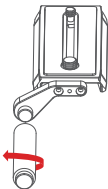

靠左侧安装时，跟焦安装管转接支架的螺柱和跟焦安装管的螺孔配合，逆时针方向锁紧。

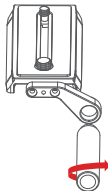

靠右侧安装时，跟焦安装管转接支架的螺孔和跟焦安装管的螺柱配合，顺时针方向锁紧。

⚠ 注意：为防止跟焦器安装管松脱，请按照上图示意的位置关系来安装跟焦安装管转接支架和跟焦安装管

增高组件的使用

在以下情况下，您可以根据需要使用增高组件：

- 使用的相机太矮，无法调节俯仰轴的平衡
- 使用的镜头太短，无法安装跟焦器
- 需要安装跟焦器用于变焦

⚠ 注意：在安装增高组件前，如果已经安装了跟焦安装管转接支架，请先拆下跟焦安装管转接支架

首先将增高块固定在快装板两端的螺孔中，然后将另一块快装板按同样的方式固定到增高块上即可。

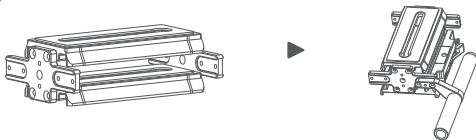

增高组件上预留了跟焦安装管转接支架的安装位置，可以根据跟焦器的安装需要，选择合适的位置安装跟焦安装管转接支架。

平衡调节

⚠ 注意：平衡调节可以参考第36页，Air 2的平衡检查功能，按照检查结果的指示来进行调节会更加方便

锁定横滚轴

将横滚电机锁拨到锁止位，转动横滚臂到图示位置，此时横滚臂会自动锁止。

⚠ 注意：如横滚臂在与航向臂重叠位置被锁止，请先解锁横滚电机，切勿强行拉拽！

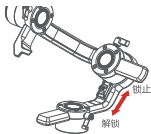

快装板前后调节

- 将相机安装在Air 2上后，松手查看镜头的指向
- 如果镜头斜向上，则相机位置靠后，松开快装底座锁紧旋钮，将快装底座向前调，直到镜头指向前方
- 如果镜头斜向下，则相机位置靠前，松开快装底座锁紧旋钮，将快装底座向后调，直到镜头指向前方
- 锁紧快装底座锁紧旋钮

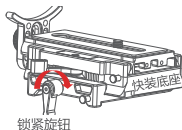

俯仰臂调节

- 将相机转动到镜头朝上，缓慢松手，检查相机朝哪个方向偏转
- 松开俯仰臂调节旋钮1，将俯仰臂2朝相机偏转的反方向调整，直到相机保持镜头向上
- 锁紧俯仰臂调节旋钮1

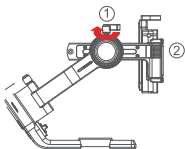

横滚臂调节

- 将横滚电机锁拨到解锁位
- 观察静止时，横滚臂的偏转方向
- 松开横滚臂调节旋钮1，将横滚臂2朝着偏转的反方向调节，直到横滚臂2保持水平
- 锁紧横滚臂调节旋钮1

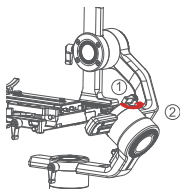

航向臂调节

- 将Air 2水平侧放，使航向臂保持水平，缓慢松手，检查相机朝哪个方向偏转
- 松开航向臂调节旋钮1，将航向臂2朝着偏转的反方向调节，直到航向臂2保持水平
- 锁紧航向臂调节旋钮1

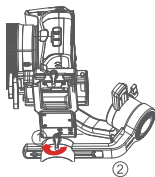

⚠ 注意: 如果没有调节好航向臂的平衡，会导致航向电机发热，跟随过冲等情况，且盗梦空间功能无法正常使用

云台功能

按键功能

按键功能定义如下：

状态	操作	电源键	Fn键	扳机键	M键	手轮	摇杆按键
主界面	按1次	录制/停止	极速跟随	——	手轮功能切换	控制M键选择的 功能	开启/关闭航向跟随
	按2次	拍照	盗梦空间	归中	——		开启/关闭横滚跟随
	按3次	——	——	自拍	——		开启/关闭俯仰跟随
	长按3秒	开机/关机	自动调参	——	——		——
	保持	——	——	全锁定	——		——

状态	操作	拨盘上键	拨盘下键	拨盘左键	拨盘右键	菜单键	拨盘
主界面	按1次	进入/退出快门调节	进入/退出光圈调节	进入/退出ISO调节	打开/关闭实时预览	进入菜单	调节跟随速度
	长按3秒	——	——	——	——	休眠/唤醒	——
相机参数界面	按1次	进入/退出快门调节	进入/退出光圈调节	进入/退出ISO调节	打开/关闭实时预览	进入菜单	调节相机参数
菜单界面	按1次	选择条上移	选择条下移	返回上一级	进入下一级/选择/确认	退出菜单	调节选中项值
关机状态	升级模式	摇杆按键+电源键					

主界面图标介绍：

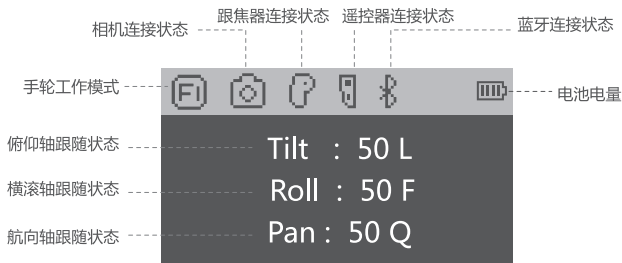

跟随状态说明：

数字：跟随速度 L：锁定 F：跟随 Q：极速跟随

⚠ 注意：相机，跟焦器，遥控器等设备如未连接，对应的图标都不会显示

开机、关机、休眠、唤醒的操作

Air 2安装好相机，并调节好平衡后，即可开机使用。长按电源键3秒直到屏幕显示出主界面信息，电机开始工作即可。开机状态下，长按电源键3秒，屏幕会关闭，电机停止工作，Air 2完成关机。

▲ 注意：在开机过程中，如果屏幕还显示在“MOZA”画面上，没有显示主界面就松开了电源键，Air 2无法正常启动

开机状态下，如果长按菜单键3秒，则Air 2进入休眠状态，电机停止工作，屏幕仍会继续显示云台信息。再次长按菜单键3秒，则电机恢复工作，Air 2从休眠状态中被唤醒。

相机参数设置和控制的操作系统

▲ 注意：使用Air 2控制相机前，请先按照第23页所述，连接好相机控制线。Air 2支持使用USB控制方式的相机的自动识别和参数调节，如果您使用的相机不支持USB控制方式，如松下GH3、GH4、GH5等，您需要手动选择相机型号

Air 2支持的相机和功能如下表所示

相机			云台			可用功能								
品牌	型号	操作	操作	连接线型号	供电	拍照	录制	光圈	快门	ISO	曝光补偿	取景器		
佳能	1DX	—	设置相机类型为佳能-USB Menu>Camera set>Select>Canon-USB	M3C-Mini	—	OK	OK	OK	OK	OK	OK	OK		
	OK					OK	OK	OK	OK	OK	OK			
	OK					OK	OK	OK	OK	OK	OK			
	OK					OK	OK	OK	OK	OK	OK			
	6D			M3C-Micro		OK	OK	OK	OK	OK	OK	OK	OK	OK
	6D2					OK	OK	OK	OK	OK	OK	OK	OK	OK
	80D					OK	OK	OK	OK	OK	OK	OK	OK	OK
	5D4					OK	OK	OK	OK	OK	OK	OK	OK	OK
5Ds		OK	OK	OK	OK	OK	OK	OK	OK	OK				
索尼	RX10 II	将相机的USB 工作模式设置 为电脑控制	设置相机类型为索尼-USB Menu>Camera set>Select>Sony-USB	M3C-Micro	OK	OK	—	OK	OK	OK	—	OK		
	RX10 III					OK	OK	OK	OK	OK				
	RX100M4					OK	OK	OK	OK	OK				
	A5100					OK	OK	OK	OK	OK				
	A6300					OK	OK	OK	OK	OK				
	A6500			OK		OK	OK	OK	OK					
	A7S			OK		OK	OK	OK	OK					
	A7S II			OK		OK	OK	OK	OK					
	A7R			OK		OK	OK	OK	OK					
	A7R II			OK		OK	OK	OK	OK					
	A7 II			OK		OK	OK	OK	OK					
同上	—	设置相机类型为索尼-Multi Menu>Camera set>Select>Sony-Multi	MCSC-Multi	—	OK	OK	—	—	—	—				
松下	GH3	—	设置相机类型为松下-2.5mm Menu>Camera set>Select>Panas-2.5mm	MCSC-Remote	—	OK	OK	—	—	—	—			
	GH4					OK	OK	—	—	—				
	GH5					OK	OK	—	—	—				
	GH5S					OK	OK	—	—	—				
	G7					OK	OK	—	—	—				
	G85					OK	OK	—	—	—				
	G9					OK	OK	—	—	—				

▲ 注意：Air 2支持的相机型号和功能会逐步扩充，请登录官网或联系官方技术服务，获取最新的相机功能支持列表

- 录制/停止：单击电源键
- 拍摄照片：双击电源键
- 调节快门：拨盘上键（TV）
- 调节光圈：拨盘下键（AV）
- 调节ISO：拨盘左键（ISO）



调节相机参数时，先按下对应的键，屏幕上会显示对应的值，然后转动拨盘调整该值，调整完成后，再次按下对应的按键，即可关闭相机的参数调整。

- 打开/关闭实时预览：按下拨盘右键，即可打开或者关闭相机的实时预览功能，打开实时预览后，相机屏幕会亮起，显示取景内容

⚠ 注意：

- 1.只有唤出相机的参数设置后，转动拨盘才能调节相机对应的参数，默认状态下转动拨盘会调节跟随速度。关于跟随状态的更多信息请参考第30页
- 2.部分相机（如索尼A7S2）带有传感器，如果取景器前方被遮挡，会自动关闭相机屏幕，切换到取景器观看预览，请在相机设置中将预览设置为显示屏即可

使用手轮进行跟焦，横滚控制等操作

Air 2的手轮有4种不同的工作模式，通过M键能直接切换手轮的工作模式，切换后，屏幕上的手轮模式图标会对应发生变化。

- (F1)** 跟焦器通道1，控制跟焦器
- (F2)** 跟焦器通道2，控制跟焦器
- (FE)** 电子跟焦通道，如果您使用的相机和镜头支持电子跟焦，则可以使用该通道控制电子跟焦功能
- (R)** 横滚轴控制，控制Air 2的横滚轴转动

⚠ 注意：

- 1.如果只接入一个跟焦器，则F1通道和F2通道都可以控制该跟焦器，如果接入两个跟焦器，则两个通道分别控制不同的跟焦器
- 2.使用电子跟焦功能，请参考官网相机功能支持列表

使用扳机键进行归中、自拍、全锁定等操作

Air 2的扳机键有以下三个操作，能够快速控制Air 2的运动。

- 双击：归中，让云台迅速回到起始位置
- 三击：自拍，Air 2转动到镜头朝向使用者的方向
- 长按：进入全锁定状态，松开后回到原来的跟随状态

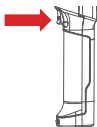

⚠ 注意：在进行归中和自拍的操作时，请勿随意转动手柄，否则最终到达的位置会有偏差

切换跟随状态

Air 2的每个轴都带有跟随功能，且各轴的跟随功能可以独立控制。

Air 2一共有8种跟随模式：

编号	俯仰轴	横滚轴	航向轴	备注
1	锁定	锁定	锁定	全锁定
2	锁定	锁定	跟随	航向跟随
3	锁定	跟随	锁定	横滚跟随 (FPV)
4	锁定	跟随	跟随	航向-横滚跟随
5	跟随	锁定	锁定	俯仰跟随
6	跟随	锁定	跟随	航向-俯仰跟随
7	跟随	跟随	锁定	横滚-俯仰跟随
8	跟随	跟随	跟随	全跟随

- 开启/关闭航向轴的跟随：单击摇杆按键
- 开启/关闭横滚轴的跟随：双击摇杆按键
- 开启/关闭俯仰轴的跟随：三击摇杆按键

调节各轴的跟随速度：默认状态下，拨动拨盘，屏幕上各轴的跟随速度值会改变。

快速进入全锁定：按住扳机键，各轴的跟随模式都会变成 'L'，即锁定状态，松开扳机键后回到原来的状态。

极速跟随：单击Fn键，航向轴进入极速跟随模式，'Pan' 后面的字母变为 'Q'，其余轴的跟随状态不变。再次单击Fn键，退出极速跟随，航向轴回到原来的跟随状态。

使用Fn键实现极速跟随、盗梦空间及自动调参等功能

Fn键为特殊功能按键，能够快速进入各种特殊功能。

- 单击：打开/关闭极速跟随，在极速跟随下，航向轴的反应会非常迅速，能够快速地完成转向
- 双击：打开/关闭盗梦空间，使用盗梦空间时，将镜头指向被拍摄对象，然后向左或右拨动摇杆，能拍摄出360°旋转的画面。盗梦空间的转动速度可以调节，参考第34页。
- 长按：进行自动调参，在自动调参时，要将Air 2安装好三脚架，放置在水平、稳定的桌面上，Air 2会逐个轴来检测负载情况，并自动调节电机的出力值，使云台达到最佳的使用状态

菜单功能

菜单类型的识别与操作方法

- 如果选中的项目右侧有 ‘>’ 标志，则该项目有下级菜单，点击拨盘上/下键移动选择条，然后点击拨盘右键进入下级菜单
- 如果选中的项目右侧有 ‘[]’ 标志，内含数字，则转动拨盘可调节该项目的值
- 如果选中的项目右侧有 ‘()’ 标志，内含选项，则点击拨盘右键可以使该项目在几个选项中切换

⚠ 注意：

- 1.如果当前菜单列表中某项目右侧有 ‘*’ 标志，则当前列表为最终选项，点击拨盘上/下键移动选择条，点击拨盘右键将 ‘*’ 移动到选中的项目上，启用该项目
- 2.如果选中的项目及其所在的菜单列表中的其它项目右侧均没有标志，则点击右键可以执行该选项一次，执行过程中该项目右侧显示 ‘?’ 执行完成后显示 ‘OK’ ，如果执行失败则显示 ‘ERR’

一级菜单	二级菜单	三级菜单	四级菜单	五级菜单	说明		
Camera Set>	Select>	Shutter cable	—		设置Air 2的相机控制模式为快门模式		
		Canon-USB	—		设置Air 2的相机控制模式为佳能相机USB控制		
		Sony-Multi	—		设置Air 2的相机控制模式为索尼相机Multi控制		
		Sony-USB	—		设置Air 2的相机控制模式为索尼相机USB控制		
		Panas-2.5mm	—		设置Air 2的相机控制模式为松下相机Remote接口控制		
		Panas-USB	—		设置Air 2的相机控制模式为松下相机USB控制		
		Nikon-USB	—		设置Air 2的相机控制模式为尼康相机USB控制		
		Fuji-USB	—		设置Air 2的相机控制模式为富士相机USB控制		
	Parameter>	BMD-LANC	—		设置Air 2的相机控制模式为BMD摄影机Remote控制		
		Aperture[]	—		调节相机的光圈		
		Shutter[]	—		调节相机的快门		
ISO[]		—		调节相机的ISO			
Gimbal Set>	Motor>	Switch()	—		开启/ 关闭电机		
		Power>	Autotune	—		自动调参	
				Level>	Ultra light		设置电机的参数为超轻
					Light		设置电机的参数为轻
					Medium		设置电机的参数为中
					Heavy		设置电机的参数为重
			Ultra heavy			设置电机的参数为超重	
			Custom>	Tilt[]		设置俯仰电机的出力值	
				Roll[]		设置横滚电机的出力值	
				Pan[]		设置航向电机的出力值	
			Filter	Tilt[]		设置俯仰电机的滤波参数	
		Roll[]			设置横滚电机的滤波参数		
		Pan[]			设置航向电机的滤波参数		
		Follow>	Switch>	Tilt()		开启/ 关闭俯仰电机的跟随	
				Roll()		开启/ 关闭横滚电机的跟随	
				Pan()		开启/ 关闭航向电机的跟随	
			Speed>	Tilt[]		设置俯仰电机的速度	
				Roll[]		设置横滚电机的跟随速度	
				Pan[]		设置航向电机的跟随速度	
			Dead angle>	Tilt[]		设置俯仰电机的死区角	
				Roll[]		设置横滚电机的死区角	
				Pan[]		设置航向电机的死区角	
		Manual pos>	Tilt()	—		开启/ 关闭俯仰电机的极速跟随	
			Roll()	—		开启/ 关闭横滚电机的极速跟随	
			Pan()	—		开启/ 关闭航向电机的极速跟随	
			Tilt()	—		开启/ 关闭俯仰电机的手动定位	
			Roll()	—		开启/ 关闭横滚电机的手动定位	
Pan()	—			开启/ 关闭航向电机的手动定位			

一级菜单	二级菜单	三级菜单	四级菜单	五级菜单	说明
Gimbal Set>	Operations>	Joystick>	Function>	Left-Right ()	设置摇杆左右的功能
				Up-Down ()	设置摇杆上下的功能
			Sensitivity>	Left-Right ()	设置摇杆左右的灵敏度
				Up-Down ()	设置摇杆上下的灵敏度
			Habits>	Left-Right ()	设置摇杆左右的方向 (+ : 正向 ; - : 反向)
				Up-Down ()	设置摇杆上下的方向 (+ : 正向 ; - : 反向)
		Wheel>	Function>	Focus-1	设置手轮控制跟焦器1
				Focus-2	设置手轮控制跟焦器2
				Focus-E	设置手轮控制相机的电子跟焦
				Roll	设置手轮控制横滚轴
			Sensi[]	——	设置手轮的灵敏度
		Habits()	——	设置手轮上下的方向 (+ : 正向 ; - : 反向)	
		Trigger>	Hold>	None	设定按住扳机键无任何功能
				All lock	设定按住扳机键进入全锁定模式
				Quick follow	设定按住扳机键进入极速跟随模式
				FPV	设定按住扳机键进入横滚跟随模式
				+ P&Y follow	设定按住扳机键打开俯仰和航向跟随
				+ P follow	设定按住扳机键打开俯仰跟随
				+ R follow	设定按住扳机键打开横滚跟随
				+ Y follow	设定按住扳机键打开航向跟随
			Once>	None	设定按一次扳机键无任何功能
	Re-center			设定按一次扳机键归中	
	Selfie			设定按一次扳机键自拍	
	Shutter			设定按一次扳机键拍照	
	Twice>		None	设定按二次扳机键无任何功能	
			Re-center	设定按二次扳机键归中	
		Selfie	设定按二次扳机键自拍		
	Triple >	None	设定按三次扳机键无任何功能		
		Re-center	设定按三次扳机键归中		
		Selfie	设定按三次扳机键自拍		
	Dial	Habits()	——	设置拨盘的方向 (+ : 正向 ; - : 反向)	
	Calibration>	Offset>	Tilt[]	——	俯仰轴的平衡微调
			Roll[]	——	横滚轴的平衡微调
Pan[]			——	航向轴的平衡微调	
Balance chk>		back ---- front	——	相机前后位置的平衡检查结果	
		down ---- up	——	俯仰轴的平衡检查结果	
		left ---- right	——	横滚轴的平衡检查结果	
Gyro		——	陀螺仪校准		
Acc		——	加速度计校准		

一级菜单	二集菜单	三级菜单	四级菜单	五级菜单	说明
Advanced>	iFocus Set>	Turn off	—		关闭跟焦器
		Turn on	—		启动跟焦器
		Set Start	—		设置跟焦器的起点
		Set End	—		设置跟焦器的终点
	Inception>	Speed[]	—		设置盗梦空间的转动速度
		Smooth[]	—		设置盗梦空间的平滑度
	AHRS coeff[]	—	—		设置姿态参数
Tripod mode()	—	—		开启/关闭三脚架模式	
Configuration>	Config 1>	Save	—		将当前配置保存到配置1
		Load	—		加载配置1为当前配置
	Config 2>	Save	—		将当前配置保存到配置2
		Load	—		加载配置2为当前配置
	Config 3>	Save	—		将当前配置保存到配置3
		Load	—		加载配置3为当前配置
	Set default	—	—		恢复默认配置
About>	—	—		查看固件版本信息	

使用技巧

操作模式

Air 2提供三种操作模式，来应对不同的拍摄场景，您可以根据需要，来选择合适的操作模式。



正置模式

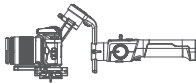

手电模式



倒置模式

⚠ 注意：切换倒置模式时，稳定器手柄沿横滚电机旋转180°，到相机的上方

陀螺仪校准

- 校准陀螺仪前，请先关闭电机，您可以长按菜单键，或者进入菜单中选择Giambal Set>Motor>Switch 关闭电机
- 将Air 2放置在稳定无晃动的桌面上保持静止不动
- 进入菜单，选择Giambal Set>Calibration>Gyro，然后点击拨盘右键，屏幕上Gyro后面会出现一个问号“？”
- 等待约5秒，当问号变成‘OK’后，表示校准完成

Offset	>		Offset	>
Balance chk	>		Balance chk	>
Gyro	?		Gyro	OK
Acc			Acc	

⚠ 注意：

- 如果云台使用正常,可以不用校准,如果云台静置时,出现明显的漂移现象,才需要进行陀螺仪校准
- 如果校准后出现‘ERR’提示,则校准失败,请再次尝试

加速度计校准

- 校准加速度计前，请先关闭电机，您可以长按菜单键，或者进入菜单中选择Gimbal Set>Motor>Switch来关闭电机
- 将Air 2放置在水平的桌面上，使云台完全水平，并保持静止

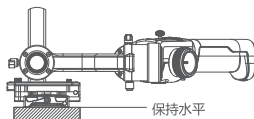

- 进入菜单，选择Gimbal Set>Calibration>Acc，然后点击拨盘右键，屏幕上Acc后面会出现一个问号‘？’
- 等待约5秒，当问号变成‘OK’后，表示校准完成

Offset	>		Offset	>
Balance chk	>		Balance chk	>
Gyro			Gyro	
Acc	?		Acc	OK

⚠ 注意：

- 1.如果云台使用正常，可以不用校准，如果云台开机后相机不处于水平状态，才需要进行加速度计校准。在紧急的拍摄情况下，如果来不及进行加速度计校准，可以通过平衡微调来将云台调节到相机水平。在拍摄工作结束后，再进行校准操作
- 2.如果校准后出现‘ERR’提示，则校准失败，请再次尝试

平衡检查

稳定器的平衡调节，是使用过程中最常见的问题。Air 2新增的平衡检查功能，能够自动检查各个轴的平衡状况，并指导用户进行正确的调节

- a. 给Air 2安装好三脚架，开机后放置在水平的桌面上
- b. 进入菜单，选择Calibrate>Balance chk，云台开始检查平衡调节的情况

⚠ 注意：电机在关闭状态下，无法进行平衡检查，屏幕上会提示‘ERR’，请长按菜单键，开启电机后再试



- back--*--front：相机的前后位置，如果*号靠近back，则相机比较靠后，需要向前调节；如果*号靠近front，则相机的位置比较靠前，需要向后调节。参考第25页
- down--*--up：俯仰轴上下位置，如果*号靠近down，则俯仰臂太低，需要向上调节；如果*号靠近up，则相机俯仰臂太高，需要向下调节。参考第25页
- left--*--right：横滚轴左右位置，如果*号靠近left，则横滚臂太左，需要向右调节；如果*号靠近right，则横滚臂太右，需要向左调节。参考第26页

⚠ 注意：

- 1.当屏幕显示出检查结果后可以长按菜单键，关闭电机，然后调节各轴。调节完成后，再次长按菜单键启动电机
2. 航向轴的平衡暂无法检查，请按照第26页的操作指导进行调节

平衡微调

在紧急的拍摄作业情况下，如果Air 2不能保持相机水平，又来不及进行传感器校准，可以通过平衡微调，来将相机调节到水平状态。

- a. 将稳定器开机，然后打开相机的水平仪，观察俯仰轴和航向轴的偏移情况
- b. 进入菜单，选择Gimbal Set>Calibration>Offset，将光标移动到不平的轴上，然后转动拨盘，调节该轴的微调值，直到相机完全水平

Offset	>		Tilt	[50]
Balance chk	>	▶	Roll	[50]
Gyro			Pan	[50]
Acc				

⚠ 注意：

- 1.平衡微调只能在约±5°的范围内来调节各轴的角度，偏差太多的情况下，无法完全调平相机
- 2.平衡微调只是临时性的解决办法，在完成拍摄后，还是需要进行加速度计校准
- 3.平衡微调的参数不会保存，重启后会失效

固件升级

如果您使用电脑升级固件，请按以下步骤操作：

- a. 将Air 2关机
- b. 向下按住摇杆键，不要松开，然后单击电源键，屏幕上会显示 ‘Boot Mode’ ，即进入固件升级状态
- c. 将Air 2通过USB-C数据线连接到电脑上，启动升级软件
- d. 升级软件会自动进入固件升级界面，等待固件下载完成后，点击 ‘升级’ 按钮，等待约30秒
- e. 升级过程中，Air 2屏幕会显示 ‘Upgrading ’，升级完成后，屏幕会显示 ‘Upgrade success’ ，然后重启Air 2即可

如果您使用APP升级固件，请按以下步骤操作：

- a. 将Air 2关机
- b. 向下按住摇杆键，不要松开，然后单击电源键，屏幕上会显示 ‘Boot Mode’ ，即进入固件升级状态
- c. 启动APP，点击蓝牙图标搜索Air 2设备并连接
- d. APP会自动进入固件升级界面，等待固件下载完成后，点击 ‘升级’ 按钮，等待约5分钟
- e. 升级过程中，Air 2屏幕会显示 ‘Upgrading ’，升级完成后，屏幕会显示 ‘Upgrade success’ ，然后重启Air 2即可

规格参数

Air 2	
载重	0.3kg~4.2kg
尺寸	230*240*470 mm
俯仰包络尺寸	110 mm
横滚包络尺寸	100 mm
航向轴机械限位范围	360°无限位
横滚轴机械限位范围	360°无限位
俯仰轴机械限位范围	+180°~-95°
电池类型	INR18650D250
电池容量	2500 mAh
工作电压	15.2V
静态电流	150mA
通信方式	蓝牙4.0 BLE
	2.4G
	USB
相机控制接口	Mini USB 5V 1A
假电池供电接口	DC2.0mm 7.8V 1A
附件供电接口	DC5.5mm 12V 2A
直流供电输入接口	DC5.5mm 14.8V 3A
工作温度	0--50°C

产品保修卡

用户资料

产品型号	MOZA Air 2
购买日期	
姓 名	
电 话	
地 址	

经销商信息（签章）

产品保修条例

保修期

自购机日起，云台主体保修12个月；云台电机、电池保修3个月。设备外壳、说明书、USB线材、包装等不在“一年免费保修服务”范围内，您可以选择有偿服务。

七日内免费退货

自购机日起7日内，根据国家最新三包规定，您可以选择退货（按票面金额一次性退清货款）、换货（更换同型号同规格的产品）或修理。

八至十五日免费换货或修理

自购机日起第8日至第15日内，主机出现性能故障，并经特约维修中心检测，确认非人为损坏的本身质量问题，您可以选择换货(更换同型号、同规格产品)或修理；但是更换的范围，只限于产品主机，其他配件无质量问题，不能更换；购买者在以下条件下不享受免费保修服务，您可以选择有偿服务。

1. 超过三包有效期的；
2. 无三包凭证及有效发货票的，但能够证明该产品在三包有效期内的除外；
3. 包修凭证上的型号与修理产品型号不符或者涂改的；
4. 非本公司特约维修人员拆动造成损坏的；
5. 因不可抗拒力造成损坏的；
6. 未按产品使用说明书要求使用、维护、保养而造成损坏的。



Follow us
魔爪社交媒体



MOZA WeChat
魔爪微信公众号

GUDSEN

INVENTED FOR VIDEO

Gudsen Technology Co., Ltd

Web: www.gudsen.com